

A
B
C
D
E
F

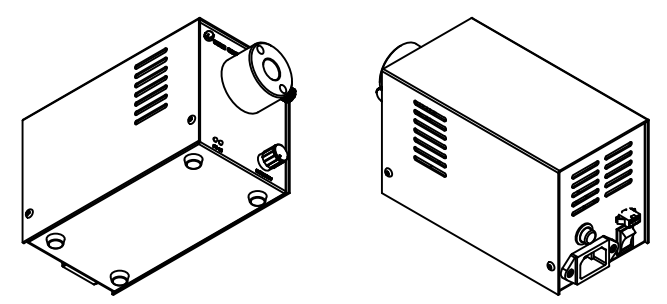
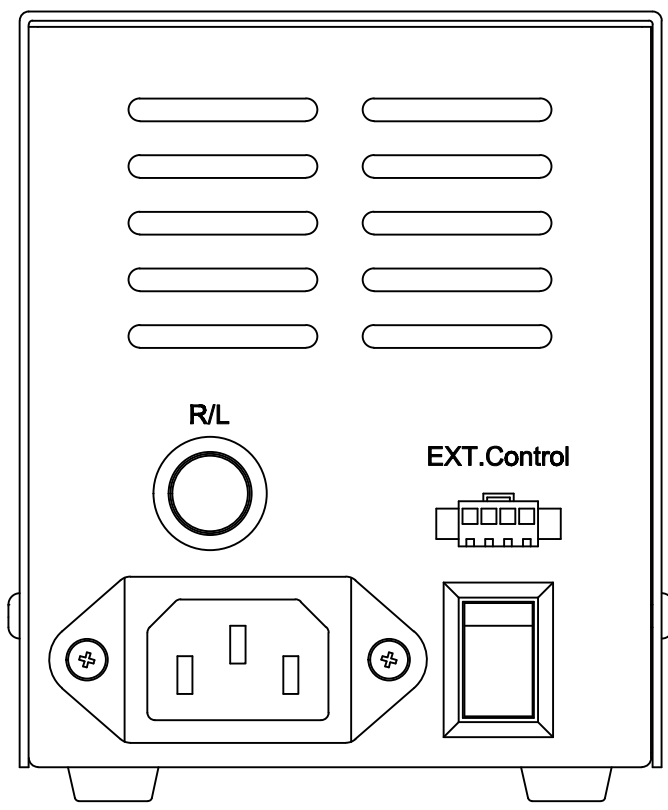
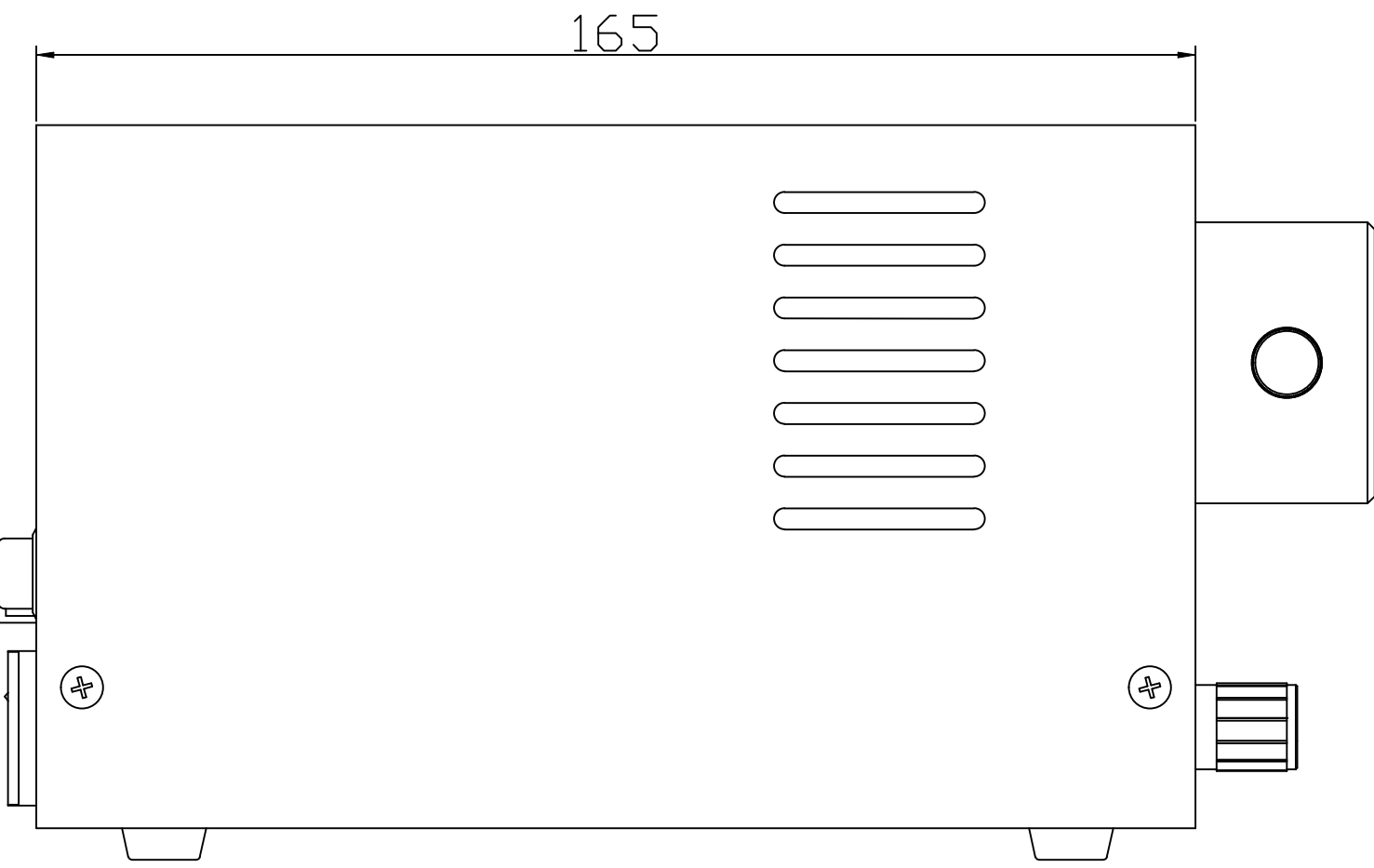
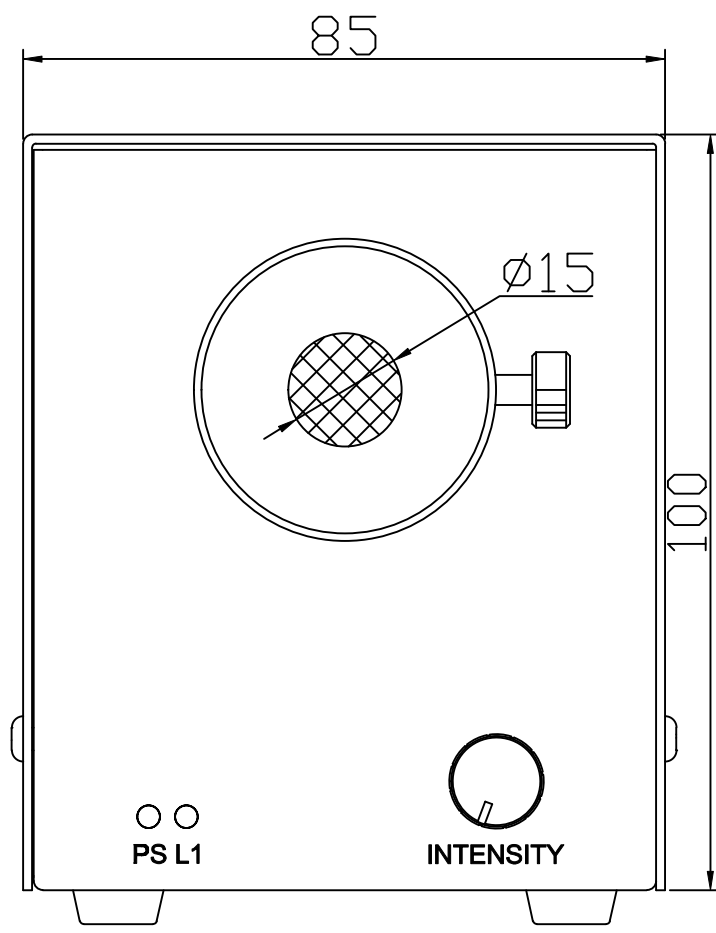

Itemref	Quantity	Material:	Article No./Reference		
Designed by DESIGNED_BY	Checked by CHECKED_BY	Approved by - date 2014-1-1	Filename WFB-05	Date 2014-1-1	Scale 1/1
WAVECREST(SH)			WFB-05-USER		
			WFB-05-0000	Edition VER.1.0	Sheet 1