

A  
B  
C  
D  
E  
F

A  
B  
C  
D  
E  
F

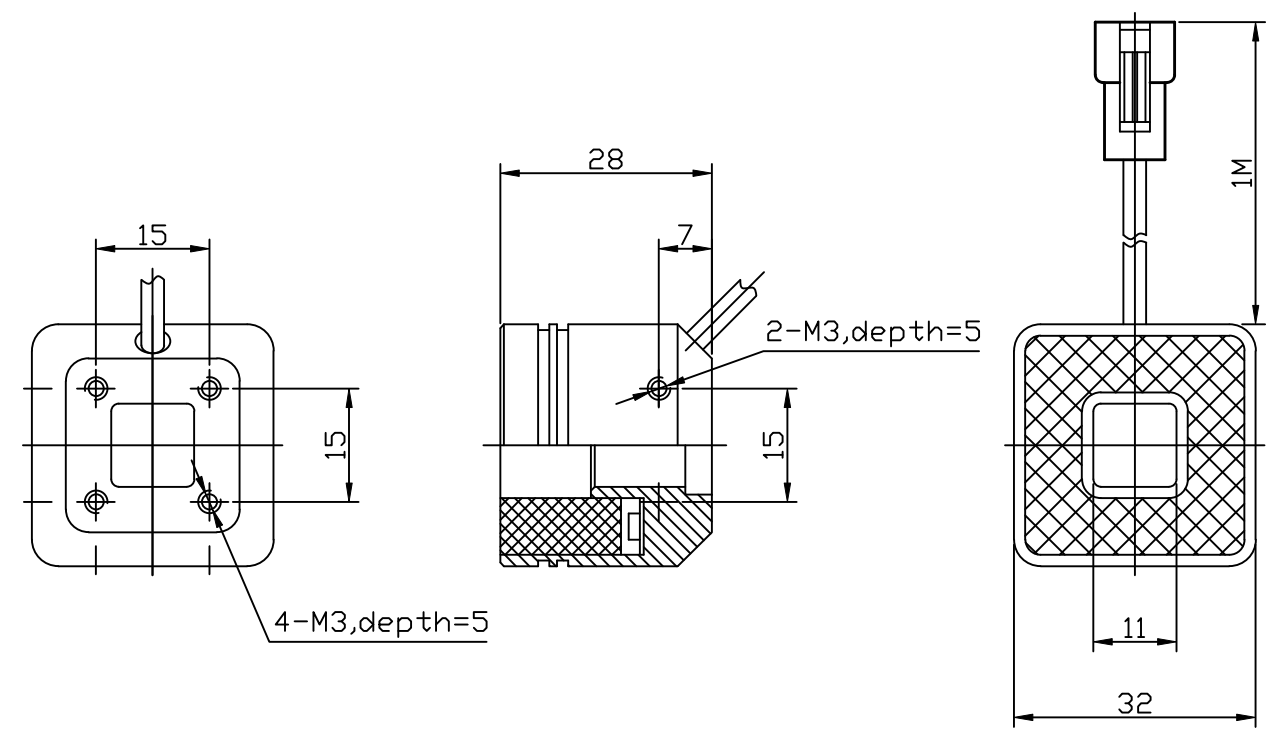

Details of Connector

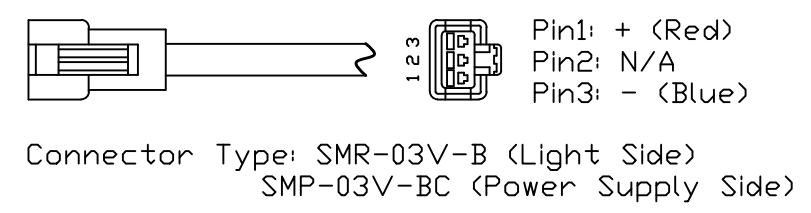

Specification:

MODEL	WLFL2-SQ32-W/-B/-G/-UV	-Y/-R/-IR850/-IR940
Wavelength(nm)	6500K/470/525/390	590/625/850/940
Power Supply	DC24V/1.7(W)	DC24V/1.2(W)
Weight	40g	

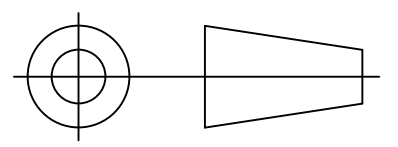
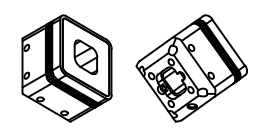

Itemref	Quantity	Material:	Article No./Reference		
Designed by DESIGNED_BY	Checked by CHECKED_BY	Approved by - date 2012-10-10	Filename WLFL2-SQ32	Date 2012-10-10	Scale 1/1
WAVECREST(SH)			WLFL2-SQ32-USER		
			WLFL2-SQ32-0000	Edition VER.1.0	Sheet 1